



Work. Play. Recycle.

The Fibrex Group manufactures an exclusive line of multi compartment recycling receptacles. The Mobius Designer Series combines recycling and high-end design at an affordable price. This is our most attractive unit and is perfect for use in high profile areas such as airports, office buildings, schools and universities. The innovative Mobius recycling station comes standard with one, two, three or four compartments featuring molded drop-in openings for collecting bottles & cans, paper products and trash. Each compartment holds up to 25 gallons and is fitted with a rigid plastic liner. These indoor recycling stations are available in an unlimited combination of colors and finishes, and are perfect for even the most discriminate of locations. Our beautiful high-gloss gel coats, satin aluminum & satin brass finishes are built to last. Custom drop-in openings give our customers an opportunity to create and choose a style that fits their collection methods and waste stream diversion.



The Fibrex Group, Inc.
4165 Pruden Blvd- Bldg 2
Suffolk, VA 23434
Phone 1-800-346-4458
Fax 1-800-444-8380
ruben@fibrexgroup.com
www.fibrexgroup.com

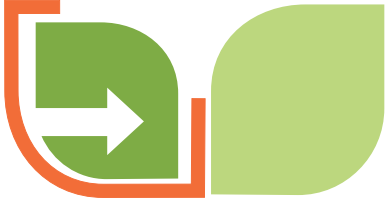

Mobius Model Features









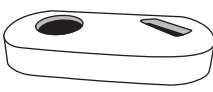
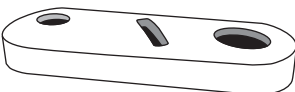

| Model | Code | Capacity | Weight | Dimensions |
|-------------------------|--------|----------------------|----------|-----------------|
| Mobius DS 1 compartment | DS0250 | 1 x 25 gal. | 32 lbs. | 18" dia x 32" |
| Mobius DS 2 compartment | DS2500 | 2 x 25 gal. | 65 lbs. | 38" x 18" x 34" |
| Mobius DS 3 compartment | DS3750 | 3 x 25 gal. | 90 lbs. | 52" x 18" x 34" |
| Mobius DS 4 compartment | DS4100 | 2 x 25 & 2 x 20 gal. | 110 lbs. | 52" x 18" x 34" |

Mobius 1

Mobius 2

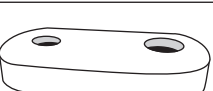
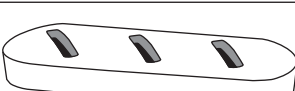
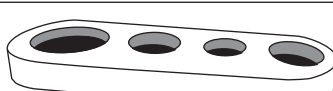
Mobius 3

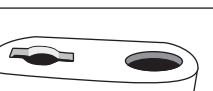
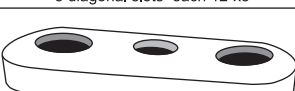
Mobius 4

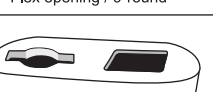
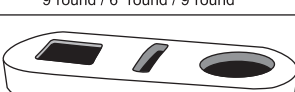
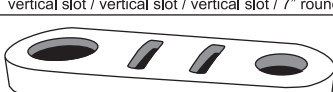
| | | | |
|---|--|--|--|
|  1.5" x 7" square |  9" round / 12" x 3" diagonal slot |  7" round / 12" x 3" diagonal slot / 9" round |  7" round / 12" x 3" vertical slot / 5" round / 9" round |
|  7" round |  10" round / 10" square |  9" round / 5" round / 7" round |  9" round / 7" round / 12" x 3" vertical slot / 7" round |
|  8" round |  5" round / 7" round |  3 diagonal slots each 12" x 3" |  10" round / 7" round / 6" round / 8" round |
|  9" round |  Flex opening / 9" round |  9" round / 6" round / 9" round " |  vertical slot / vertical slot / vertical slot / 7" round |
|  10" round |  Flex opening / 10" square |  10" square / vertical slot / 10" round |  9" round / vertical slot / vertical slot / 7" round |

Note: Custom configurations can be designed to fit your needs.

White Text on Clear Vinyl

COMPOST ONLY
 NEWSPAPER
 CD'S ONLY
 EAR PLUGS ONLY
 MIXED RECYCLABLES NO GLASS
 ALUMINUM & GLASS
 ALL PAPER
 TRASH ONLY
 WHITE OFFICE PAPER
 RECYCLING ONLY
 COLORED OFFICE PAPER
 FOOD CONTAINERS & UTENSILS ONLY
 MIXED PAPER
 COMPOSTABLE FOOD CONTAINERS WRAPPERS & COFFEE CUPS
 PLASTIC & GLASS ONLY
 ORGANIC WASTE
 OTHER WASTE
 PLASTIC ONLY
 BOTTLES & CANS
 MIXED RECYCLABLES NO GLASS
 CANS ONLY
 METAL, GLASS & PLASTIC
 FOOD CONTAINERS & UTENSILS ONLY



Black Text on Clear Vinyl

COMPOST ONLY
 NEWSPAPER
 PLASTIC
 TRASH
 ORGANIC WASTE
 MIXED PAPER
 PLASTIC & ALUMINUM
 PLASTIC & GLASS ONLY
 WHITE PAPER
 PAPER PLATES, NAPKINS & FOOD
 ALUMINUM & GLASS
 MIXED RECYCLABLES
 BOTTLES & CANS ONLY
 CANS ONLY
 #1 & #2 PLASTICS
 FOOD CONTAINERS AND UTENSILS ONLY
 NON-RETURNABLE BOTTLES AND CANS
 RETURNABLE BOTTLES AND CANS

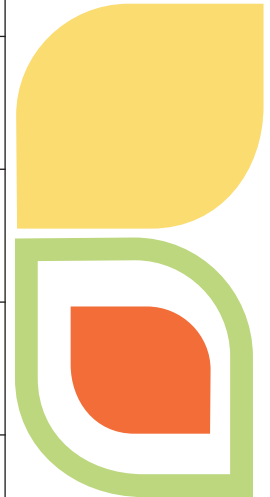

FibreX Recycling Containers can be custom tailored to your specific needs. We manufacture the highly popular Mobius Recycling Stations with multi color lids, as well as a wide variety of colors that match yours. Our in-house design & marketing staff will work with you to determine an image that works perfectly for your needs. Turnaround time is fast and convenient. Your organization's logo and colors will shine bright with digitally printed logo decals of any size. Mobius Recycling & Waste Receptacles are designed to function in the most demanding public spaces.



Great for commercial LEED buildings, office complexes, convention centers, airports, schools & universities. The most progressive organizations choose FibreX Recycling Containers to promote their green image, while collecting recyclables and diverting waste from landfills. Since 1990, FibreX designs, manufactures, sells, installs and services an innovative product line of recycling containers, waste receptacles, site furnishings & playground equipment. Providing attractive green design recycling receptacles promotes environmental stewardship while reducing waste and increasing recycling awareness.





Color Chart

| | | | |
|--------------|---------------|----------|------------|
| | | | |
| white | light Gray | Gray | Black |
| | | | |
| Brown | Beige | Tan | Rosewood |
| | | | |
| Forest Green | Mediterranean | Green | Pale Green |
| | | | |
| Blue | Pale Blue | Teal | Deep Blue |
| | | | |
| Yellow | Pale Yellow | Marigold | Orange |
| | | | |
| Red | Classic Red | Burgundy | Salmon |

We offer very competitive factory direct pricing on our extensive selection of sustainable design recycling containers, waste receptacles, benches, picnic tables, playgrounds & solar bollards. All our products are made with the maximum amount of recycled content, are built to last and covered by the best warranties in the industry.

Fibrex clients can expect superior green design products and dependable customer service support done with pride and attention to detail. Please contact us for more information and pricing at 1-800-346-4458 or on the web at www.fibrexgroup.com

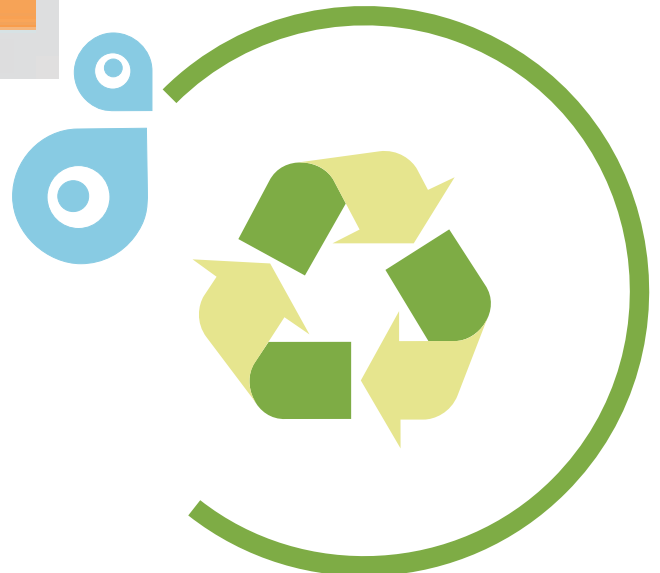



Work. Play. Recycle.

Mobius Flex

Recycling meets high-end design at an affordable price



The new stylish Mobius Flex™ is not only very attractive, but also extremely durable and user friendly. This 2 compartment receptacle is made from high quality rotational molded plastic and has an innovative anti-scratch surface. The Mobius Flex™ is perfect for collecting waste and recyclables in public spaces. Built to withstand the most demanding high traffic public areas and attractive enough for the most discriminate of locations. The generously sized drop-in openings give you the flexibility to collect a wide variety of recyclables, compostables and waste. Also perfect for the very popular single stream recycling programs, since the special recyclables opening will accept a wide variety of materials. The recyclables are collected inside with two rigid plastic liners that hold 25 gallons each.

This recycling container is perfect for schools, universities, airports, military installations & facilities, malls, apartments & condominiums, hotels, convention centers and office buildings. The Mobius Flex™ is an exclusive Fibrex Recycling Container product which was designed and manufactured by our team of experts. We can offer you the most competitive factory direct pricing, custom designs and excellent customer service. The Mobius Flex™ looks attractive, is very durable and is priced at \$695 retail and \$350 wholesale.

Fibrex Recycling Containers always contain the maximum amount of recycled content and are in use in over 3,000 communities, parks, educational facilities, corporate offices, military bases, retail establishments, multi-family housing, and the hospitality industry all over the United States and Canada. We offer low factory direct pricing and a large variety of designs, sizes and custom models to fit today's wide range of recycling, composting and waste needs. Providing attractive user friendly recycling receptacles in public places promotes good environmental stewardship while reducing waste and increasing recycling participation rates. Call us today at 1-800-346-4458 for more information or visit us on the web at www.fibrexgroup.com





We currently offer several decorative colors but will be happy to custom produce the Flex™ in the color of your choice. The Mobius Flex™ has several molded-in graphics application areas making it very suitable for custom graphics. You can use our standard graphics and labeling or your own. We will apply your current logo designs or one of our excellent sales representatives will work closely with you to design your custom logos and recycling labeling. The Fibrex Group specializes in custom branded recycling containers and site furnishings. Your logo, your color, and your message can all be integrated into our products.

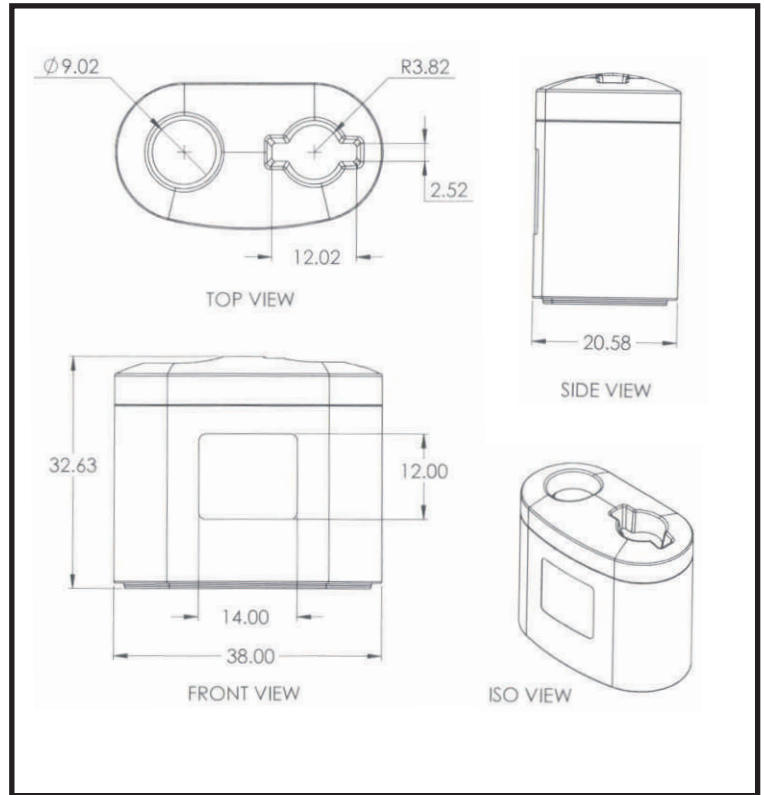

Color Chart



Forest Green



Tan



Black



Gray



Blue

Specifications: 52" L x 18" W x 32" H

Weight: 40 Lbs

Capacity: 2 x 25 Gallon

The Fibrex Group, Inc.

4165 Pruden Blvd- Bldg 2
Suffolk, VA 23434
Phone 1-800-346-4458
Fax 1-800-444-8380
ruben@fibrexgroup.com
www.fibrexgroup.com

